

HAAN

FLOOR SANITIZER

USER MANUAL

SV-60

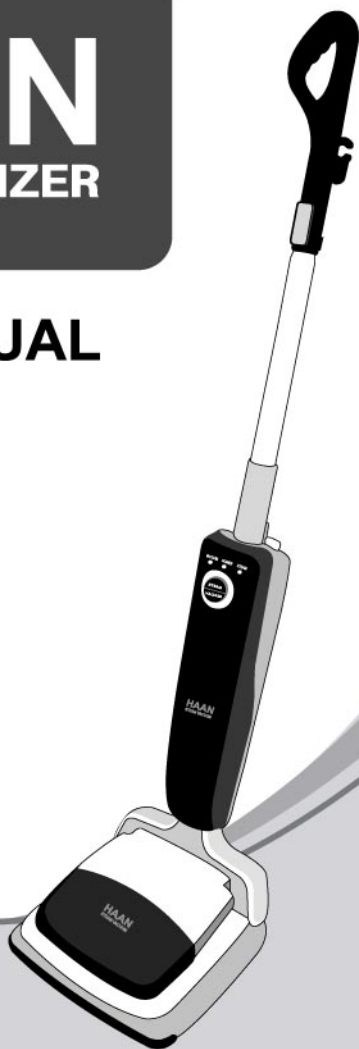

IMPORTANT SAFETY INSTRUCTIONS

■ When using your **steam vacuum cleaner**, basic safety precautions should always be observed, including the following:

1. Read all instructions before using your steam vacuum cleaner.
2. Use this product only for its intended use.
3. Do not direct steam at people, animals, or at electrical outlets.
4. Unplug from outlet when not in use and before conducting maintenance or troubleshooting.
5. Do not leave steam vacuum cleaner unattended.
6. Do not leave the steam vacuum cleaner connected to an electrical outlet when not in use.
7. Do not service steam vacuum cleaner when it is plugged in.
8. Do not use with damaged cord or plug.
9. Do not use steam vacuum cleaner if it has been dropped, damaged, left outdoors or dropped into water, return it to a service center.
10. Do not handle steam vacuum cleaner with wet hands.
11. Do not pull or carry by cord, use cord as a handle, close door on cord, pull cord around sharp corners or expose cord to heated surfaces.
12. Do not use appliance in an enclosed space filled with vapor given off by oil-base paint thinner, some moth proofing substances, flammable dust, or other explosive or toxic vapors.
13. Do not use on leather, wax polished furniture or floors, synthetic fabrics, velvet or other delicate, steam-sensitive materials.
14. Do not use for any purpose other than described in this User's Guide.
15. Never put descaling, aromatic, alcoholic or detergent products into the steam vacuum cleaner, as this may damage it or make it unsafe for use.
16. Unplug by grasping the plug, not the cord.
17. Close attention is necessary when used by or near children.
18. If the circuit breaker activates while using the steam function, discontinue product use immediately and contact the customer support center.
(Beware of the risk of electrical shock.)
19. Do not allow the product to be disassembled and/or modified by anyone other than an authorized service technician.
(Doing so can result in fire and/or electrical shock.)
20. To protect against the risk of electric shock, do not use the product outdoors and/or in damp areas.
21. To protect against the risk of electric shock, do not immerse your steam vacuum cleaner into water or any other liquids.
22. Turn your steam vacuum cleaner off before unplugging.
23. Use only on flat, horizontal surfaces. Do not use on walls, counters or windows.
24. Do not add cleaning solutions, scented perfumes, oils or any other chemicals to the water used in your steam vacuum cleaner as this may damage it or make it unsafe for use. Use regular tap water or distilled/purified water if the tap water in your area is very hard.

25. Do not handle the ultra-microfiber pad immediately after turning your steam vacuum cleaner off. Place it on the floor protector pad to cool down before removing.
26. Never leave your steam vacuum cleaner in one spot on any surface for any period of time. Always place on the floor protector pad and make sure that the steam vacuum cleaner is turned off.
27. Extreme caution should be exercised when using steam vacuum cleaner to clean stairs.
28. Never use your steam vacuum cleaner without ultra-microfiber cleaning Pad attached during steam cleaning.
29. Keep your work area well lit.
30. Avoid picking up hard, sharp objects including broken glass with the cleaner. They may damage the cleaner.
31. Do not use without dust cup or filters in place. Empty the dust cup frequently when picking up very fine materials such as powder.
32. Always disconnect cord from electrical outlet before servicing the cleaner.
33. Unplug your steam vacuum cleaner when not in use. Turn off all controls before unplugging.
34. After steam cleaning, wait at least five minutes to cool before removing the ultra-microfiber pad.
35. After steam cleaning, place your steam vacuum cleaner on the floor protector pad until it has cooled.
36. When the product is in need of repair or service, contact the service center, and do not attempt to disassemble or repair the product directly.
37. Do not use the product without the dust cartridge and filters properly in place. Empty the dust cartridge frequently after vacuuming fine substances such as powder.
38. Do not leave appliance when plugged in. Unplug from outlet when not in use and before servicing.
39. To Reduce The Risk Of Electric Shock - Do not use outdoors or on wet surfaces
40. To Reduce The Risk Of Electric Shock - Do not use on wet surfaces. Do not expose to rain. Store indoors.
41. To Reduce The Risk Of Electric Shock - Use indoors only.
42. To Reduce The Risk Of Electric Shock - Do not expose to rain. Store indoors
43. To Reduce The Risk Of Electric Shock - Do not use on wet surfaces.
44. To Reduce The Risk Of Electric Shock - Do not use motorized nozzle on wet surfaces.
45. Only motorized nozzle is double-insulated. To reduce risk of electric shock - Connect vacuum cleaner to a properly grounded outlet.
46. Do not immerse. To reduce risk of electric shock - Use only on carpet moistened by cleaning process
47. To Reduce The Risk Of Electric Shock - Use Indoors Only.
48. To Reduce The Risk Of Electric Shock - Do Not Expose To Rain - Store Indoors.
49. This hose contains electric wires. To reduce the risk of electric shock, do not use or repair a damaged hose.
50. Do not allow to be used as a toy. Close attention is necessary when used by or near children.
51. Use only as described in this manual. Use only manufacturer' s recommended attachments.

52. Use only as described in this manual. Use only manufacturer's recommended attachments.
53. Do not use with damaged cord or plug. If appliance is not working as it should, has been dropped, damaged, left outdoors, or dropped into water, return it to a service center.
54. Do not pull or carry by cord, use cord as a handle, close a door on cord, or pull cord around sharp edges or corners. Do not run appliance over cord. Keep cord away from heated surfaces.
55. Do not unplug by pulling on cord. To unplug, grasp the plug, not the cord.
56. Do not handle plug or appliance with wet hands.
57. Do not put any object into openings. Do not use with any opening blocked; keep free of dust, lint, hair, and anything that may reduce air flow.
58. Keep hair, loose clothing, fingers, and all parts of body away from openings and moving parts.
59. Turn off all controls before unplugging.
60. Use extra care when cleaning on stairs.
61. Do not use to pick up flammable or combustible liquids, such as gasoline, or use in areas where they may be present.
62. Do not pick up anything that is burning or smoking, such as cigarettes, matches, or hot ashes.
63. For an appliance intended for use with a motorized nozzle and without a current-carrying hose: Always turn off this appliance before connecting or disconnecting motorized nozzle.
64. Connect to a properly grounded outlet only. See Grounding Instructions.
65. Improper connection of the equipment-grounding conductor can result in a risk of electric shock. Check with a qualified electrician or service person if you are in doubt as to whether the outlet is properly grounded. Do not modify the plug provided with the appliance - if it will not fit the outlet, have a proper outlet installed by a qualified electrician.
66. Not for Space Heating Purposes

23. Ne pas aspirer des liquides inflammables ou combustibles, comme de l'essence, et ne pas faire fonctionner dans des endroits où peuvent se trouver de tels liquides.
24. Ne brancher qu' à une prise de courant avec mise à la terre. Voir les instructions visant la mise à la terre.
25. Ne pas aspirer de matières en combustion ou qui dégagent de la fumée, comme des cigarettes, des allumettes ou des cendres chaudes.
26. Ne pas utiliser l'appareil si le sac à poussière ou le filtre n' est pas en place.
27. Un conducteur de terre mal raccordé peut entraîner un risque de choc électrique. Consulter un électricien ou un technicien d' entretien qualifié si vous n' êtes pas certain que la prise est correctement mise à la terre. Ne pas modifier la fiche fournie avec l'appareil - si elle ne peut être insérée dans la prise, faire installer une prise adéquate par un électricien qualifié.
28. Pour éviter d' être blessé par les pièces en mouvement, débrancher avant l'entretien.
29. **POUR ÉVITER LES RISQUES DE CHOC ÉLECTRIQUE, DÉBRANCHER AVANT LE NETTOYAGE OU L' ENTRETIEN.**
30. Ce flexible contient des fils électriques. Pour réduire les risques de choc électriques, ne pas utiliser ni réparer un flexible endommagé.
31. Toujours mettre l' interrupteur de l' appareil à la position ARRÊT avant de brancher ou de débrancher la brosse à moteur.

IMPORTANTES MESURES DE SÉCURITÉ

1. Ne pas laisser l'appareil sans surveillance lorsqu'il est branché. Débrancher lorsque l'appareil n'est pas utilisé et avant l'entretien.
2. Pour réduire les risques de choc électrique, ne pas utiliser à l'extérieur et ne pas aspirer de matières humides.
3. Pour réduire les risques de choc électrique, ne pas aspirer de matières humides, ne pas exposer à la pluie et ranger l'aspirateur à l'intérieur.
4. Pour réduire les risques de choc électrique, utiliser à l'intérieur seulement.
5. Pour réduire les risques de choc électrique, ne pas exposer à la pluie et ranger l'aspirateur à l'intérieur.
6. Pour réduire les risques de choc électrique, ne pas aspirer de matières humides.
7. Pour réduire les risques de choc électrique, ne pas aspirer de matières humides avec la brosse à moteur.
8. Seule la brosse à moteur est protégée par une isolation double. Pour réduire les risques de choc électrique, brancher l'aspirateur à une prise de courant avec mise à la terre.
9. Ne pas immerger. Pour réduire les risques de choc électrique, utiliser seulement sur un tapis mouillé par le dispositif de nettoyage.
10. Pour réduire les risques de choc électrique, utiliser à l'intérieur seulement.
11. Pour réduire les risques de choc électrique, ne pas exposer à la pluie et ranger l'aspirateur à l'intérieur.
12. Ce flexible renferme des fils électriques. Pour réduire les risques de choc électriques, ne pas utiliser ni réparer un flexible endommagé.
13. Ne pas permettre aux enfants de jouer avec l'appareil. Une attention particulière est nécessaire lorsque l'appareil est utilisé par des enfants ou à proximité de ces derniers.
14. N' utiliser que conformément à cette notice avec les accessoires recommandés par le fabricant.
15. Ne pas utiliser si le cordon ou la fiche est endommagé. Retourner l'appareil à un atelier de réparation s' il ne fonctionne pas bien, s' il est tombé ou s' il a été endommagé, oublié à l' extérieur ou immergé.
16. Ne pas tirer soulever ni traîner l'appareil par le cordon. Ne pas utiliser le cordon comme une poignée, le coincer dans l'embrasure d' une porte ou l'appuyer contre des arêtes vives ou des coins. Ne pas faire rouler l'appareil sur le cordon. Garder le cordon à l' écart des surfaces chaudes.
17. Ne pas débrancher en tirant sur le cordon. Tirer plutôt la fiche.
18. Ne pas toucher la fiche ni l' appareil lorsque vos mains sont humides.
19. N' insérer aucun objet dans les ouvertures. Ne pas utiliser l'appareil lorsqu' une ouverture est bloquée. S' assurer que de la poussière, de la peluche, des cheveux ou d' autres matières ne réduisent pas le débit d' air.
20. Maintenir les cheveux, les vêtements amples, les doigts et toutes les parties du corps à l' écart des ouvertures et des pièces mobiles.
21. Mettre toutes les commandes à la position ARRÊT avant de débrancher l'appareil.
22. User de prudence lors du nettoyage des escaliers.

ADDITIONAL IMPORTANT SAFEGUARDS

1. This is a 1440-watt appliance. To avoid a circuit overload, do not operate a high wattage appliance on the same circuit.
2. If an extension cord is absolutely necessary, the marked electrical rating should be at least as great as the electrical rating of the appliance. Cords rated for less amperage may overheat. Care should be taken to arrange the cord so that it cannot be pulled or tripped over.
3. Do not leave unattended when the product is connected to a power supply/electrical outlet.
4. To reduce the risk of electric shock, this appliance has a polarized plug (One blade is wider than the other). This plug will fit in a polarized outlet only one way. If the plug does not fit fully in the outlet, reverse the plug. If it still does not fit, contact a qualified electrician to install the proper outlet. Do not change the plug in any way.

SAVE THESE INSTRUCTIONS

FOR HOUSEHOLD USE ONLY

Commercial use of this unit voids the manufacturer's warranty.

WARNING: This appliance is equipped with a grounded-type 3-wire power cord (3-prong plug). This plug will only fit into an electrical outlet made for a 3-prong plug. This is a safety feature. If the plug should fail to fit the outlet, contact an electrician to replace the outlet. Do not attempt to circumvent the safety purpose of the grounding pin.

CONSERVER CES INSTRUCTIONS

- A. Ne pas aspirer de matières en combustion ou qui dégagent de la fumée, comme des cigarettes, des allumettes ou des cendres chaudes.

FEATURES

Your **Steam-Vacuum Cleaner** utilizes steam to remove tough grease, dirt and grime. Steam is nature's purest and most powerful cleaner for safely cleaning all hard floor surfaces in your home without harsh chemicals, thus being perfectly ecological. It cleans your tile, hardwood, linoleum, and vinyl floors.

WARNING: Your Steam-Vacuum Cleaner is designed to clean hard floor surfaces that will withstand high heat. Do not use on unsealed wood or unglazed ceramic floors. On surfaces that have been treated with wax or some no wax floors, the sheen may be removed by the heat and steam action. It is always recommended to test an isolated area of the surface to be cleaned before proceeding. We also recommend that you check the use and care instructions from the floor manufacturer.

IMPORTANT: **Never** leave the appliance in one spot on any surface for any period of time. Always place your floor sanitizer on the floor protector pad and make sure that the Steam-Vacuum Cleaner is turned off.

CAUTION: Use a grounded receptacle. Use only a heavy duty extension cord rated for 15 amps minimum - Do not use an ordinary extension cord.

IMPORTANT: Do **NOT** add cleaning solutions, scented perfumes, oils or any other chemicals to the water used in this appliance. **Use regular water or distilled/purified water if the tap water in your area is very hard.**
Always empty water after use.

ULTRA-MICROFIBER PADS FOR HAAN FLOOR SANITIZER

What is an ultra-microfiber?

An ultra-microfiber is a textile fiber that is thinner than a microfiber (1.0dtex). Specifically, to be defined as an ultra-microfiber, it should be less than 0.2dtex. The Ultra-Microfiber pad by HAAN Corporation is made of 0.17dtex ultra-microfibers.

<How To Use Ultra-Microfiber Pads>

- (1) Please make sure that you always use completely dried pads.
- (2) As high temperature steam passes through a pad to contact the floor to kill germs, molds, mites and to provide a certain amount of water necessary for cleaning, it is natural that the pad gradually absorbs moisture. After a certain length of time, the pad repels water and becomes damp.
- (3) To keep the floor clean and dry, replace the pad when it is dirty.

<How To Clean and Store>

- (1) Ultra-microfiber pads are easy to wash. Soak pads for about 1-2 hours in cold or lukewarm water with laundry detergent and hand-wash them.
(If you use a washing machine, use a brief and light cycle, for example, delicate or wool cycle.)
- (2) Using a washing machine may shorten the lifespan of the pads.
- (3) Dry pads indoors by natural ventilation.
(If you use a dryer, please do not use a fabric softener and adjust it to cold cycle.)

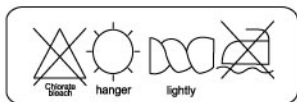

PART NAMES AND ASSEMBLY



⦿ Make sure to check for all accessories!



Ultra-Microfiber Pad



Floor Protector Pad



Pad Tray

STEAM CLEANER USAGE

1 Affix Cleaning Pad



Align the roll portion of the product with the center of the pad and affix.

2 Confirm Cleaning Pad Placement

Suction Opening



(O)

Do not block the suction opening.

Suction Opening



(X)

Any blockage of the suction opening by the cleaning pad can result in the weakening of suction.

3 Stand

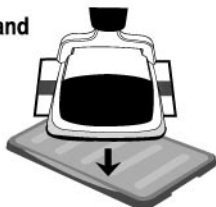

After affixing the cleaning pad, make sure to place the cleaner on the stand. (For initial steam generation, the water may come to a boil.)

4 Filling with Water (when the water tank is removed)

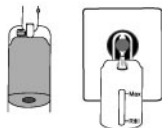

Open the water tank cap and fill the water tank directly with water up to the maximum indicator line. Then make sure to secure the cap back on the water tank. (The use of purified water is recommended.)

4 Filling with Water (when the water tank is attached)

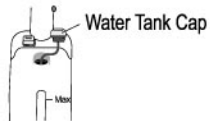

Open the water tank cap and fill the water. Then make sure to secure the cap back on the water tank. (The use of purified water is recommended.)

5 Check the Steam Lamp

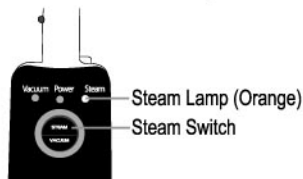

Press the steam switch to light the orange steam lamp and begin water heating for steam generation.

※ Upon completion of steam usage, pressing the steam switch will result in the turning off of the orange steam lamp after approximately 3 seconds.

VACUUM CLEANER USAGE

Vacuum Lamp (Green)

Vacuum Switch



Pressing the vacuum switch lights the green vacuum lamp and begins suction.

VACUUM CLEANER USAGE



Press

Pressing both the steam switch and vacuum switch lights both the orange steam lamp and green vacuum lamp, and both functions can then be used simultaneously.

ATTENTION!



Washing the ultra microfiber cleaning pad after each use is recommended. To maximize the cleaning and polish of floors, alternation of cleaning pads at appropriate intervals is required. If the cleaning pad has become highly saturated, replace with a dry one. (Use two or more pads for floor areas totaling 80~100 square meters.)



If the water tank has been filled beyond the maximum indicator line, or if the cleaner is used in a horizontal position to reach under such objects as sofas and beds, water may leak slightly from the water tank cap. (The water tank cap has an air hole for the entrance of air.)

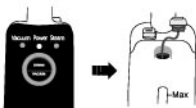

If the water refill lamp becomes lit during use, turn the product power off and fill the water tank.

The use of all water within the tank per each use of the product is recommended. (Discard any water that may remain in the tank after completion of cleaning.)



When affixing the dust cartridge, if the interior of the dust cartridge is dirty, the placement of the dust cartridge may not be precise, which can in turn cause the weakening of suction. Thus, the dust cartridge should be cleaned on a frequent basis.

Storage After Use
Coil the power cord loosely.



(X)



(O)

DUST CARTRIDGE CLEANING & ASSEMBLY INSTRUCTIONS

⚠ CAUTION Make sure to use the product after the circular filter and semi-circular filter are in place, as doing so without them can cause motor damage.

- ※ Clean the dust cartridge when suction becomes weaker than normal and/or the sound of the motor becomes louder than usual.
- ※ After cleaning with the product whenever possible, remove the dust cartridge and filters, and rinse them thoroughly. (Suction can be weakened when the dust cartridge is full.)
- ※ Suction can be weakened if assembly has not been completed precisely.

(Disassembly)



- ① Grasp the guides on each side and raise the dust cartridge upward.

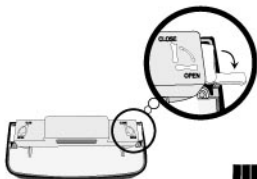

- ② After pointing the dust cartridge cover downward, turn the levers on each side.

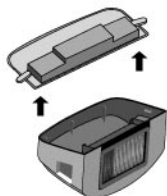

- ③ Grasp the case and detach the cover.



- ④ Grasp the circular filter and remove.

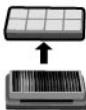

- ⑤ Grasp the semi-circular filter and remove from the cover.



- ⑥ Wash clean the circular and semi-circular filters under running water.

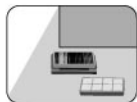

- ⑦ After washing, place in a well-ventilated, shaded area, and reassemble when fully dry. (Suction is weakened if reassembled while still wet.)

(Assembly) ※ Suction is weakened if the dust cartridge cover is not assembled correctly. Follow the assembly instructions for proper assembly.

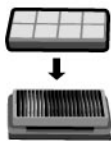

- ① Align the semi-circular filter with the guides in the cover and insert fully.

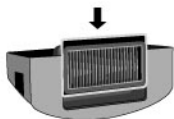

- ② Align the circular filter with the hole in the cover and insert fully.

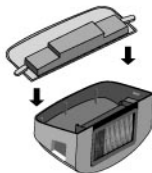

- ③ Turn the lever inward and lock the case and cover.

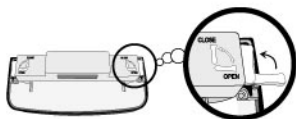

- ④ Assemble the case and cover with the levers of the case on the outside and rotated. (Suction can be weakened if the levers are on the inside.)

BRUSH BLOCKAGE CLEANING

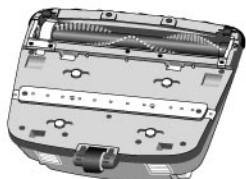

1. Remove the screw from bottom.



2. Remove the locker cover.



3. Take the belt & brush out from the vacuum hole.

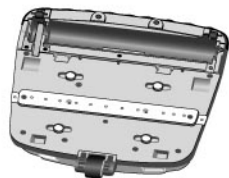

4. Clean the brush

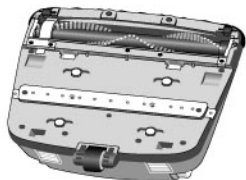

5. Assembly order is in reverse order of disassembly

- ※ Do not force too much power to screw on
- ※ Only clean the brush when it doesn't work

PAD TRAY DISASSEMBLY AND ASSEMBLY INSTRUCTIONS

1. Turn the rotate lock ring counter clockwise and disable the locking mechanism.
2. Press down on the pad tray and push toward the direction of the arrows.
3. Remove the pad. (If any foreign substance exists, wash clean.)
4. Align the pad tray with the guides and while pressing down, push in the opposite direction of the arrows.
5. Turn the rotate lock ring clockwise and fasten securely to the product.

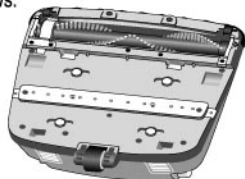

CARPET TRAY

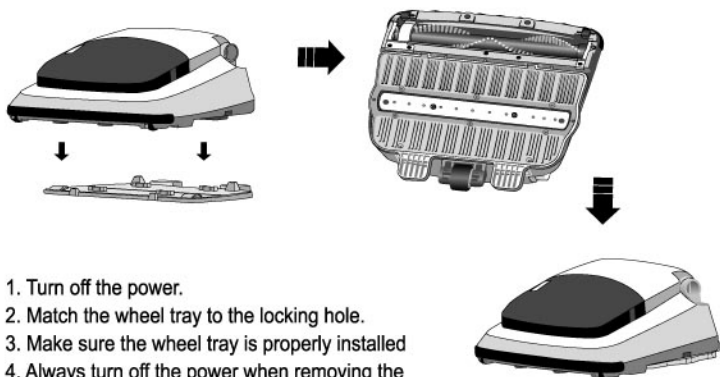

1. Turn off the power.
2. Match the wheel tray to the locking hole.
3. Make sure the wheel tray is properly installed
4. Always turn off the power when removing the tray by hand or foot.

(During the steam operation, do not touch the wheel tray.)

※ Wheel Tray is optional product

This unit doesn't have the function of adjusting the height. According to the carpet type, it is necessary to purchase optional carpet tray.

Do not force too much power on the pole.



HEPA FILTER CLEANING AND ASSEMBLY

(Disassembly)

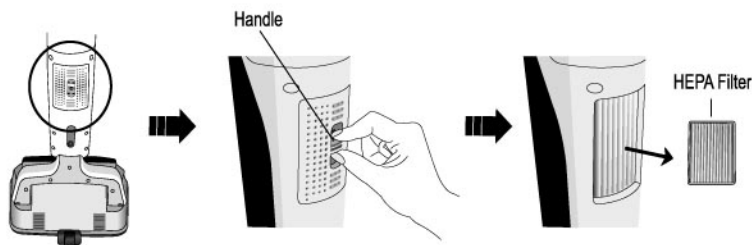

- ① Grasp and lift off the cover to the HEPA filter located at the rear of the product and remove the HEPA filter.



- ② Only remove the dust from the HEPA filter.

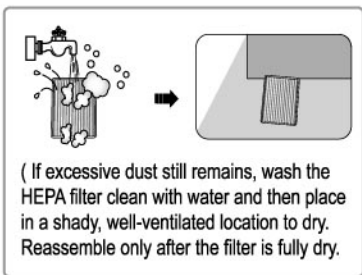

(If excessive dust still remains, wash the HEPA filter clean with water and then place in a shady, well-ventilated location to dry. Reassemble only after the filter is fully dry.

(Assembly)



- ※ When assembling the filter, first insert the lower water tank portion, and push in until a “click” sound is heard.

WATER TANK REMOVAL AND ASSEMBLY

※ When there is no more water in the water tank, you will hear a vibration sound from the main unit. To refill the water tank and continue to sanitize, turn your floor sanitizer off. Unplug the unit from the electrical wall outlet and remove the water tank and refill the water tank as before.

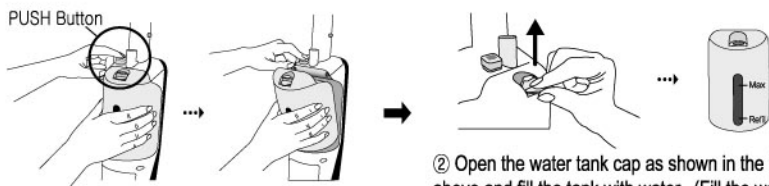

① Press the PUSH button and remove the water tank.

② Open the water tank cap as shown in the image above and fill the tank with water. (Fill the water tank up to the maximum indicator line.)

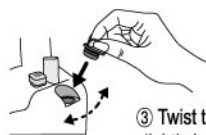

③ Twist the water tank cap slightly left and right to push closed. (If the water tank cap

cannot be closed securely, lightly wet the rubber portion of the cap and close.)

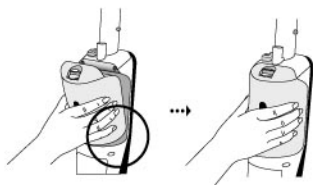

④ When assembling the water tank, first insert the bottom portion and then push into place until a "click" sound is heard.

CONVENIENCE FEATURES

► Wheel

The soft urethane wheels facilitate easy movement as well as low noise.



► Steam + Vacuum

The steam and vacuum cleaning functions can be used simultaneously.



► Motor

The product is fitted with a powerful 750W wet-type motor. (It enables dry and wet cleaning.)



► Fast

The initial wait time for steam generation is approximately 40 seconds.



TROUBLESHOOTING

※ Instances of erroneous product malfunction reports to customer support can occur. The following information can minimize inconvenience and provide solutions to minor problems, as well as help determine whether a problem represents a serious malfunction.

Problem	Troubleshooting
When first using steam, the pump makes a thumping or clicking noise.	<ul style="list-style-type: none"> - The pump emits some noise during the initial use of steam. - The pump emits noise when all the water in the water tank has been used. - No issues with the product exist even if the pump emits noise.
The water refill lamp turns on upon first use.	<ul style="list-style-type: none"> - Upon first use, no water exists in the pump and heater, causing the water refill lamp to turn on and stay lit for approximately 30 seconds before turning off. - When using the cleaner and all water is used, the water refill lamp stays lit for approximately 20 seconds after the water tank is refilled.
No steam is generated.	<ul style="list-style-type: none"> - Check to see if power supply voltage is 120V. - Check to see if the plug is securely inserted in the outlet. - Check to see if power is on. - Check to see if the water tank has been filled. - Check the weight within the water tank. <div style="text-align: center;">  </div>
Much water leaks during use.	<ul style="list-style-type: none"> - Check to see if the appropriate amount of water was added. - Check to see if the cleaning pad is wet. - Check to see if the cleaning pad provided is being used.
The air vented by the cleaner has an odor.	<ul style="list-style-type: none"> - New products can emit a rubbery smell for a short time after purchase. - Odors can arise if the dust cartridge is not cleaned for a long time.
The suction is not working.	<ul style="list-style-type: none"> - Check to see if the cleaning pad is affixed correctly in the proper alignment. Incorrect placement can result in the pad blocking the suction opening. - Check to see if the dust cartridge is in need of cleaning. - Check to see if any foreign object is lodged in the suction opening.
The sound of the cleaner during use is strange.	<ul style="list-style-type: none"> - This problem may occur if the suction function is not working properly.
During vacuum cleaner use, air is emitted via the opening of the dust cartridge.	<ul style="list-style-type: none"> - This air is from the suction opening when the motor is operating. It is not harmful in any way to the product and/or user.

Review the information above to address minor problems, and contact the customer support center if problems continue to recur or if the problem experienced is not included in the above.

One Year Limited Warranty

Your **HAAN Garmant Steamer** is warranted to be free from defects in material and workmanship for a period of one (1) year from the date of purchase when utilized for normal household use by the original purchaser only. The included Warranty Registration Card must be filled out and returned within 10 days of purchase. This is essential for your warranty to be effective should any problem arise with this product.

Should any defect covered by the terms of the limited warranty be discovered within one year, **HAAN Corporation** will repair or replace by defective part provided the unit is returned by the original purchaser, freight prepaid, to: **44 North Queen Street, Lancaster, PA 17603**

Proof of purchase date and \$12.95 for handling and return packing/shipping charges must be included.

The liability under this warranty is limited solely to the cost of the replacement parts or the complete unit at our option. **LABOUR CHARGES ARE NOT INCLUDED.**

This warranty is extended to the original purchaser of the unit and excludes all other legal and/or conventional warranties. The responsibility of **HAAN Corporation**, if any, is limited to the specific obligations expressly assumed by it under the term of the limited warranty. In no event is **HAAN Corporation** liable for incidental or consequential damages of any nature whatsoever. Some States/Provinces do not permit the exclusion or limitation of incidental or consequential damages, so the above may not apply to you. This warranty gives you specific legal rights which vary from state to state or province to province.

Important: carefully pack item to avoid damage in shipping. Be sure to attach tag to item before packing with your name, complete address, and phone number with note giving purchase information, model number and what you believe is the problem with item. We recommend you insure the package (as damage in shipping is not covered by our warranty). Mark the outside of your package "ATTENTION CUSTOMER SERVICE". We are constantly striving to improve our products therefore the specifications contained herein are subject to change without notice.

OWNERSHIP REGISTRATION CARD

Please fill out and mail the product registration card within ten (10) days of purchase in order to validate the foregoing Limited Warranty. The registration will enable us to contact you in the unlikely event of a product safety notification. By returning this card you acknowledge to have read and understood the instructions for use, and warnings set forth in the accompanying instructions.

Model : SV-60

Date purchased

Name of store

Owner's name

Address

City

State